



Overview

The **ECL-103** is a microprocessor-based programmable controller designed to control terminal units such as fan coil units, heat pump units, unit ventilators, and chilled ceilings. This controller uses the LonTalk® communication protocol and is LONMARK certified as an SCC Generic device, guaranteeing compatibility and interoperability with other manufacturers' LONMARK certified controllers.

The ECL-103 supports various input types including resistance, voltage, and digital-based ones. Moreover, it provides digital, floating, pulse width modulation, and proportional control outputs for valves, heating elements, fans, and lighting applications.

This controller works with a wide range of sensors, such as those in the Allure™ EC-Smart-View series of communicating room sensors that feature a backlit-display and graphical menus. These sensors are used for indoor temperature measurement, setpoint adjustment, fan speed selection, and occupancy state override. In addition, this controller is Open-to-Wireless™ ready, and when paired with the Wireless Receiver, it works with a variety of wireless battery-less sensors and switches.

Custom program this controller using EC-gfxProgram through either EC-Net^{AX} Pro which is powered by the Niagara^{AX} Framework® or through any LNS®-based software such as Distech Controls' Lonwatcher 3. This allows you to quickly and easily create your own control sequences capable of meeting the most demanding requirements of any engineering specification.

Applications

- Meets the requirements of the following applications:
 - Fan Coil Units
 - Heat Pumps
 - Unit Ventilators
 - Chilled Ceilings
- Improves energy efficiency when combined with:
 - Motion detectors to automatically adjust a zone's occupancy mode from standby to occupied when presence is detected
 - CO₂ sensors as part of a demand-controlled ventilation strategy that adjusts the amount of fresh air intake according to the number of building occupants
 - Light switches to control both lighting and a room's HVAC occupancy / standby mode setting
- Works with a wide range of wireless battery-less sensors

Features & Benefits

- Use the EC-gfxProgram's state-of-the-art visual programming wizard to create operation sequences that meet specific engineering specifications. EC-gfxProgram is accessible in both Niagara^{AX} Framework-based and LNS-based software, allowing you to work with your preferred network management platform.
- Accelerate custom programming development by using pre-built HVAC control sequences supplied with EC-gfxProgram.
- Available with an optional Wireless Receiver that supports up to 18 wireless inputs, letting you create wire-free installations and use various wireless battery-less sensors and switches.
- LONMARK SCC Generic certified, guaranteeing interoperability with other manufacturers' LONMARK certified controllers.
- With 4 software configurable universal inputs and 6 software configurable outputs, this controller covers all industry-standard HVAC terminal applications.
- Highly accurate universal inputs support thermistors and resistance temperature detectors (RTDs) that range from 0 Ohms to 350 000 Ohms, giving you the freedom of using your preferred or engineer-specified sensors, in addition to any existing ones.
- Rugged hardware Inputs and Outputs eliminate need for external protection components, such as diodes for 12V DC relays.

ECL-103 Controller



Model	ECL-103
Points	10-Point Controller
Universal hardware inputs	4
Allure EC-Smart-View ¹	4
Wireless inputs ²	18
15 Vdc Power Supply	■
Digital (triac) outputs	4
Universal output	2
Product Number	CDIL-103X-00

1. A controller can support a maximum of two Allure EC-Smart-View models equipped with a CO₂ sensor. The remaining connected Allure EC-Smart-View models must be without a CO₂ sensor.
2. All controllers are Open-to-Wireless ready. Available when an optional Wireless Receiver is connected to the controller. Some wireless sensors may use more than one wireless input from the controller.

Recommended Applications

Model	ECL-103
2 Pipe Fan Coil	■
2 Pipe Fan Coil with Changeover Sensor	■
4 Pipe Fan Coil	■
Heat Pump Unit	■
Unit Ventilator	■
Chilled Ceiling	■

Open-to-Wireless Series – Wireless Receiver Add-on



To reduce the cost of installation, and minimize the impact on existing partition walls, the Wireless Receiver enables these controllers to communicate with a line of wireless battery-less room sensors and switches. These Wireless Receivers are available in EnOcean 315MHz and 868.3MHz versions.



Note that controllers have one wireless port to support a single Wireless Receiver.

For more information about the EnOcean and Open-to-Wireless technologies, refer to the Open-to-Wireless Solution Guide. For more information about the Wireless Receiver module, refer to the [Wireless Receiver Datasheet](#). These documents can be found on our web site.

Supported Platforms



EC-Net^{AX} Solution

The EC-Net^{AX} multi-protocol integration solution is web-enabled and powered by the Niagara^{AX} Framework, establishing a fully Internet-enabled, distributed architecture for real-time access, automation and control of devices. The EC-Net^{AX} open framework solution creates a common development and management environment for integration of LONWORKS[®], BACnet[®] and other protocols. Regardless of manufacturer and protocol, the EC-Net^{AX} system provides a unified modeling of diverse systems and data, providing one common platform for development, management and enterprise applications.



LONWORKS Network Services (LNS)

The LNS[®] client-server platform allows multiple users, running different LNS-compatible applications, to access a common source for the directory, installation, management, monitoring and control services for the network system being managed. Distech Controls' Lonwatcher is an example of a LNS-based network management tool that can use Plug-Ins to configure and monitor controllers and devices in the control system.

EC-Net^{AX} Wizards and LNS Plug-Ins

EC-gfxProgram Graphical Programming Interface (GPI)

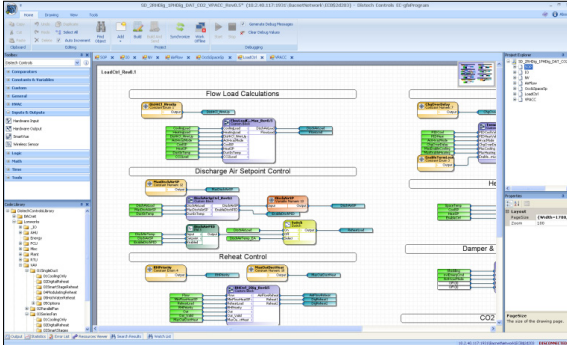

Distech Controls' EC-gfxProgram is a programming tool that allows you to quickly create control sequences by "dragging and dropping" block objects and then linking the objects with a simple "click, select and release". Select objects from an extensive library of over 100 commonly used functions as well as create your own custom blocks. With a user-friendly interface and intuitive programming environment, HVAC programming could not be easier. Refer to the EC-gfxProgram datasheet for more information.

- Program both ECP and ECL Series LONWORKS and ECB Series BACnet controllers with the same tool.
- Supplied as freeware – there are no associated licensing costs.
- Live debugging allows user to view code execution, input/output values and to detect errors in real-time.
- A code library for managing your favorite or most commonly used code or code sections.

EC-Net^{AX} Scheduling / EC-Schedule LNS Plugin / EC-gfxProgram EC-Schedule

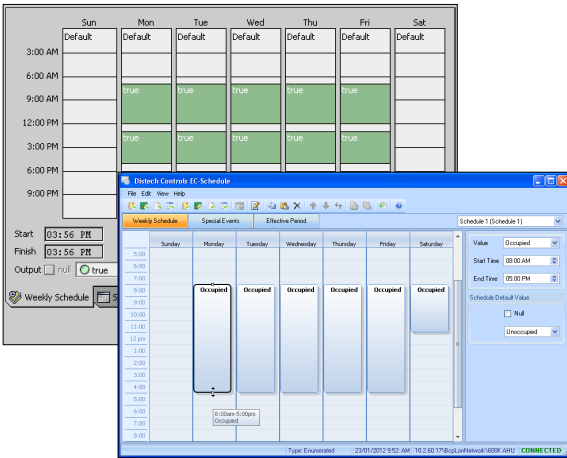

Configure the controller's built-in schedules and holidays from the EC-Net^{AX} solution (ECB and ECL series controllers), LNS (ECL series controllers), or directly from within EC-gfxProgram (ECB and ECL series controllers) with an easy-to-use point, drag, and click interface. It features a weekly schedule for regular, repeating, events by "time-of-day" and "day-of-week", while a holiday schedule is available to define events for specific days.

- Easily configure schedules using a graphical slider.
- Allows you to easily copy and paste entries. Duplicate a schedule entry for Monday to Friday.
- Special events allow you to set exceptions such as holidays to a schedule.
- Holidays can be set for recurring events such as the 9th day, or the 3rd Thursday of a given month.
- A schedule has an effective period during which it is active.
- Schedule provides Next State and Time to Next State that are ideal for use with programming functions such as Optimum Start or Morning Warm Up.

Complementary Products

Temperature Sensors

Allure EC-Smart-Vue Series



Line of communicating room temperature sensors with communication jack, a backlit-display and configurable graphic menus that allow occupants to set occupancy, setpoint adjustment, fan speed, or any other system parameters. Models are available with any combination of the following options: Humidity sensor, motion sensor, and CO₂ sensor. The ECO-Vue™ icon () shows how environmentally-friendly the zone's energy consumption is in real time.

Allure EC-Sensor Series



Line of discrete temperature sensors. Models are available with the following options: Communication jack, occupancy override button, setpoint adjustment, and fan speed selection.

Open-to-Wireless Sensors and Switches

Allure Wireless Battery-less ECW-Sensor Series



Line of wireless, battery-less room temperature sensors. Models are available with the following options: Occupancy override button, setpoint adjustment, and fan speed selection.

These sensors are available in EnOcean 315MHz and 868.3MHz versions. The controller must be equipped with a [Wireless Receiver](#).

Wireless Sensors and Switches



A wide range of self-powered wireless sensors and switches, including the following: Motion detector and light sensor, 2-/4-channel wireless light switches (North American and European models), outdoor temperature sensor, surface temperature contact sensor, duct temperature sensor, and more.

These sensors are available in EnOcean 315MHz and 868.3MHz versions. The controller must be equipped with a [Wireless Receiver](#).

For more information about the available wireless sensors and switches, refer to the [Open-to-Wireless Solution Guide](#) which can be found on our web site.

Other



Terminal Block Cover

A cover designed to conceal the wire terminals. Required to meet local safety regulations in certain jurisdictions.

For more information on these or other Distech Controls products, refer to our web site.

Controller Dimensions

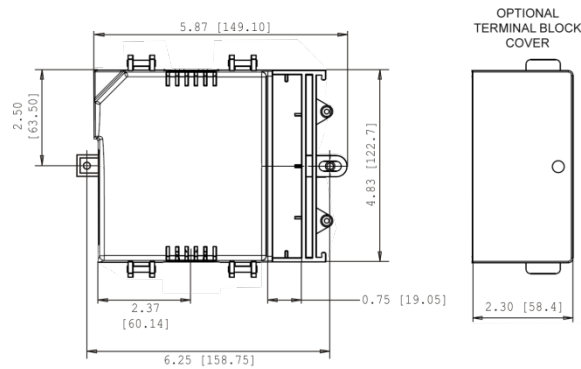

Units Legend: inches [mm]

Product Specifications

Power

Voltage	24VAC; $\pm 15\%$; 50/60Hz; Class 2
Protection	2.0A user-replaceable fuse 3.0A user-replaceable fuse for triacs when using the internal power supply
Power Consumption	10 VA typical plus all external loads ¹ 85 VA maximum

Interoperability

Communication	LonTalk protocol
Transceiver	FT 5000 Free Topology Smart Transceiver
Channel	TP/FT-10; 78Kbps
LONMARK Interoperability	Version 3.4
Guidelines	
Device Class	SCC Generic #8500
LONMARK Functional Profile	
- Input objects	Open-Loop Sensor #1
- Output objects	Open-Loop Actuator #3
- Node object	Node object #0
- Real Time Clock	Real Time Keeper #3300
- Scheduler	Scheduler #20020
- Calendar	Calendar #20030
- Programmable Device	Static Programmable Device #410
- SCC Object	SCC Generic #8500

Hardware

Processor	STM32 (ARM Cortex™ M3) MCU, 32 bit
CPU Speed	68 MHz
Memory	384 kB Non-volatile Flash (applications) 1 MB Non-volatile Flash (storage) 64 kB RAM
Real Time Clock (RTC)	Built-in Real Time Clock without battery Network time synchronization is required at each power-up cycle before the RTC becomes available
Status Indicator	Green LEDs: power status & LON TX Orange LEDs: service & LON RX

Environmental

Operating Temperature	0°C to 50°C; 32°F to 122°F
Storage Temperature	-20°C to 50°C; -4°F to 122°F
Relative Humidity	0 to 90% Non-condensing

Enclosure

Material	FR/ABS
Color	Black & blue casing & grey connectors
Dimensions (with Screws)	4.8 L × 5.9 W × 2.5" H (122.7 × 149.1 × 63.0mm)
Shipping Weight	0.92lbs (0.42kg)

Inputs

Input Types	Universal; software configurable
-Voltage	- 0 to 10VDC (40kΩ input impedance) - 0 to 5VDC (high input impedance)
-Current	0 to 20mA with 249Ω external resistor (wired in parallel)
-Digital	Dry contact
-Pulse	Dry contact; 500ms minimum ON/OFF
-Resistor	0 to 350 KΩ. All thermistor types that operate in this range are supported. The following temperature sensors are pre-configured:
<i>Thermistor</i>	10KΩ Type 2, 3 (10KΩ @ 25°C; 77°F)
<i>Platinum</i>	Pt1000 (1KΩ @ 0°C; 32°F)
<i>Nickel</i>	RTD Ni1000 (1KΩ @ 0°C; 32°F) RTD Ni1000 (1KΩ @ 21°C; 69.8°F)
Input Resolution	16-bit analog / digital converter
Power Supply Output	15VDC; maximum 80mA (4 inputs × 20mA each)

Outputs

Digital	24 VAC Triac, digital (on/off), PWM, or floating; software configurable
	- 0.5A continuous
	- 1A @ 15% duty cycle for a 10-minute period
	- PWM control: adjustable period from 2 to 65sec.
	- Floating control:
	- Min pulse on/off: 500msec.
	- Adjustable drive time period
	External or internal power supply (jumper selectable)
Universal	Linear (0 to 10VDC)
	Digital (on/off), PWM, or floating (0 - 12VDC); software configurable. Built-in snubbing diode to protect against back EMF, for example when used with a 12VDC relay.
	- PWM control: adjustable period from 2 to 65sec.
	- Floating control:
	- Min pulse on/off: 500msec.
	- Adjustable drive time period
	- 20mA maximum @ 12VDC
	- Minimum load resistance 600Ω
Output Resolution	10-bit digital / analog converter

Wireless Receiver²

Communication	EnOcean wireless standard
Number of wireless inputs ³	18
Supported Wireless Receivers	Wireless Receiver (315)
	Wireless Receiver (868)
Cable	Telephone cord
- Connector	4P4C modular jack
- Length	6ft; 2m

Electromagnetic Compatibility



CE -Emission	EN61000-6-3: 2007; Generic standards for residential, commercial and light-industrial environments
-Immunity	EN61000-6-1: 2007; Generic standards for residential, commercial and light-industrial environments
FCC	This device complies with FCC rules part 15, subpart B, class B



UL Listed (CDN & US)	UL916 Energy management equipment
Material ⁴	Plastic housing, UL94-5VB flammability rating Plenum rating per UL1995



CEC Appliance Database Appliance Efficiency Program⁵

1. External loads must include the power consumption of any connected modules such as an Allure EC-Smart-Vue. Refer to the respective module's datasheet for related power consumption information.
2. Available when an optional external Wireless Receiver module is connected to the controller. Refer to the Open-to-Wireless Solution Guide for a list of supported EnOcean wireless modules.
3. Some wireless modules may use more than one wireless input from the controller.
4. All materials and manufacturing processes comply with the RoHS directive  and are marked according to the Waste Electrical and Electronic Equipment (WEEE) directive .
5. California Energy Commission's Appliance Efficiency Program: The manufacturer has certified this product to the California Energy Commission in accordance with California law.

Allure EC-Smart-Vue

Communication	RS-485
Number of sensors per controller	Up to 4, in daisy-chain configuration
Cable	Cat 5e, 8 conductor twisted pair
Connector	RJ-45

Communication Protocols



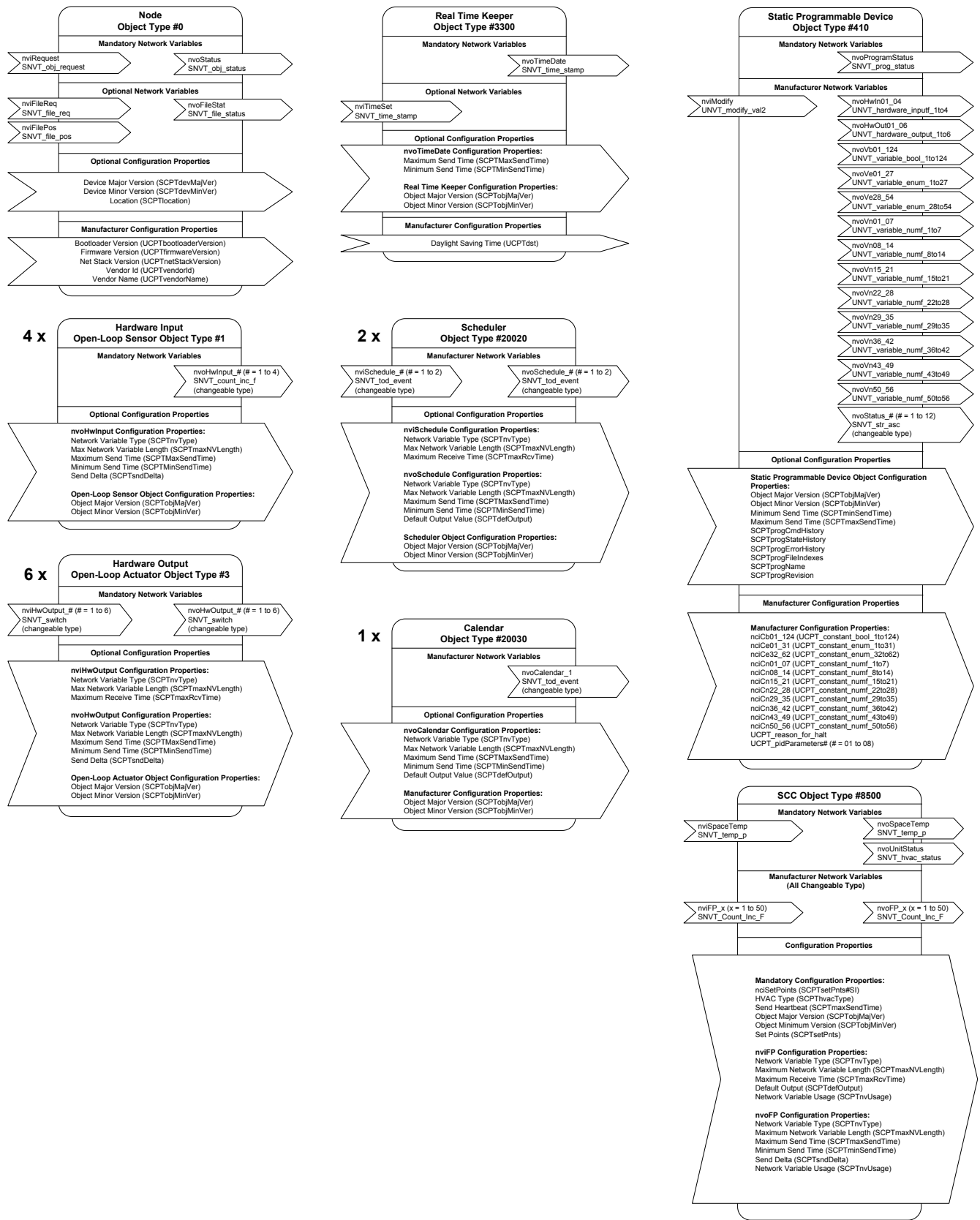

Total Quality Commitment

All Distech Controls product lines are built to meet rigorous quality standards. Distech Controls is an ISO 9001 registered company.

©, Distech Controls Inc., 2012. All rights reserved. Specifications subject to change without notice.

Images are simulated. Distech Controls, the Distech Controls logo, Open-to-Wireless, Innovative Solutions for Greener Buildings, ECO-Vue, and Allure are trademarks of Distech Controls Inc.; LONWORKS, LON, LONMARK, LNS, LonTalk are registered trademarks of Echelon Corporation; Niagara^{AX} Framework is a registered trademark of Tridium, Inc.; ARM Cortex is a registered trademark of ARM Limited; BACnet is a registered trademark of ASHRAE; Windows, Visual Basic.Net are registered trademarks of Microsoft Corporation. EnOcean is a registered trademark of EnOcean GmbH. All other trademarks are property of their respective owners.

