



### Overview

The **ECL-VAV series** are microprocessor-based programmable variable air volume (VAV) controllers designed to control any variable air volume box. Each controller uses the LonTalk® communication protocol and is LONMARK certified as an SCC VAV.

This series contains five models as follows: ECL-VAVS-O, ECL-VAVS, ECL-VAV, ECL-VVTS, and ECL-VAV-N. Models with inputs support various measurement types including resistance, voltage, and digital-based ones. All models provide digital, floating, pulse width modulation, and proportional control outputs for valves, heating elements, fans, and lighting applications. In particular, the ECL-VAVS-O, ECL-VAVS, ECL-VAV, and ECL-VAV-N models have an on-board air flow sensor with a range of 0-2 inches of water column (500 Pascal) and the ECL-VAVS-O, ECL-VAVS, ECL-VAV, and ECL-VVTS models have a built-in brushless actuator for precise damper positioning for loads requiring up to 35 inch-pounds (4 Newton-meters) of torque.

All controller models work with the Allure™ EC-Smart-Vue series of communicating sensors that feature a backlit-display and graphical menus. These sensors are used for indoor temperature measurement, setpoint adjustment, and occupancy state override. An Allure EC-Smart-Vue can be used to perform system air balancing without requiring an onsite controls engineer and to commission and troubleshoot the system. In addition, all controller models are Open-to-Wireless™ ready, and when paired with the Wireless Receiver, they work with a variety of wireless battery-less sensors and switches.

Factory preloaded applications allow these controllers, straight out of the box, to operate standard VAV equipment with a proven energy-efficient sequence of operation thereby eliminating the need for programming. The preloaded application can be selected using an Allure EC-Smart-Vue even before the network has been installed for rapid deployment or through the EC-Net<sup>AX</sup> solution using Distech Controls' *dcmfx* Applications. Or use EC-*gfm* Program through either EC-Net<sup>AX</sup> Pro, which is powered by the Niagara<sup>AX</sup> Framework® or through any LNS®-based software such as Distech Controls' Lonwatcher 3. These same controllers are fully programmable to allow you to easily create your own control sequences capable of meeting the most demanding requirements of any engineering specification.

### Applications

- Meets the requirements of VAV zone applications, including:
  - Cooling Only VAV Boxes
  - Cooling with Reheat VAV Boxes
  - Parallel Fan VAV Boxes
  - Series Fan VAV Boxes
  - Dual-Duct VAV Systems
- Improves energy efficiency when combined with:
  - Motion detectors to automatically adjust a zone's occupancy mode from standby to occupied when presence is detected
  - CO<sub>2</sub> sensors as part of a demand-controlled ventilation strategy that adjusts the amount of fresh air intake according to the number of building occupants
  - Light switches to control both lighting and a room's HVAC occupancy / standby mode setting
- Works with a wide range of wireless battery-less sensors

### Features & Benefits

- Preloaded applications save setup time: One technician can locally configure and troubleshoot the VAV with an Allure EC-Smart-Vue without any need for a programming interface.
- Integrated VAV Performance Assessment Control Charts (VPACC) control sequences, provides a means of automatically detecting when the VAV is operating outside of its design parameters including: Persistent High / Low Space Temperature, Persistent High / Low Discharge Temperature, Persistent High / Low Air Flow, and Unstable Air Flow.
- LONMARK SCC VAV certified, guaranteeing interoperability with other manufacturers' LONMARK certified controllers.
- Accurate on-board air flow sensor for precise air flow monitoring and control at low and high air flow rates, permitting you to design for maximum energy efficiency while maintaining an optimal comfort level (except ECL-VVTS models).
- Built-in actuator with a brushless motor and integrated position feedback system eliminates periodic damper re-initialization and ensures worry-free operation, providing increased occupant comfort and extended service life (except ECL-VAV-N models).
- Optimized air balancing process saves time during commissioning: The flow sensor requires no zero flow calibration, and its variable-speed motor goes to minimum and maximum flow settings in half the time of typical VAV actuators.

## Features & Benefits (continued)

- Available with an optional Wireless Receiver that supports up to 18 wireless inputs, letting you create wire-free installations and use various wireless battery-less sensors and switches. With up to 4 software configurable universal inputs and up to 6 software configurable outputs, this controller series covers all industry-standard VAV applications.
- Highly accurate universal inputs support thermistors and resistance temperature detectors (RTDs) that range from 0 Ohms to 350 000 Ohms, giving you the freedom to use your preferred or engineer-specified sensors, in addition to any existing ones.
- Rugged hardware Inputs and Outputs eliminate need for external protection components, such as diodes for 12V DC relays.

## ECL-VAV Series Controllers



Model	ECL-VAVS-O	ECL-VAVS	ECL-VAV	ECL-VVTS	ECL-VAV-N
Points	5-Point VAV	7-Point VAV	12-Point VAV	6-Point VVT	11-Point VAV
Universal hardware inputs	0	2	4	2	4
Built-in flow sensor	■	■	■		■
Allure EC-Smart-Vue <sup>1</sup>	4	4	4	4	4
Wireless inputs <sup>2</sup>	18	18	18	18	18
15 Vdc Power Supply			■		■
Universal output	1	1	2	1	2
Digital (triac) outputs	2	2	4	2	4
Built-in Actuator	■	■	■	■	
Product Number	CDIL-VASO-00	CDIL-VASX-00	CDIL-VAXX-00	CDIL-VTSX-00	CDIL-VANX-00

1. A controller can support a maximum of two Allure EC-Smart-Vue models equipped with a CO<sub>2</sub> sensor. The remaining connected Allure EC-Smart-Vue models must be without a CO<sub>2</sub> sensor.
2. All controllers are Open-to-Wireless ready. Available when an optional Wireless Receiver is connected to the controller. Some wireless sensors may use more than one wireless input from the controller.

## Recommended Applications

Model	ECL-VAVS-O	ECL-VAVS	ECL-VAV	ECL-VVTS	ECL-VAV-N
Cooling Only VAV Box	■	■		■	
Cooling w/ Reheat VAV Box	■	■		■	
Cooling w/ Reheat VAV Box & Perimeter Heating			■		
Parallel Fan VAV Box			■		
Series Fan VAV Box			■		
Dual Duct VAV Box <sup>1,3</sup>	■	■			
Large Damper VAV Box <sup>2</sup>					■
Existing Damper Actuator					■
Room Pressurization			■		

1. Two controllers are required or one controller with an external flow sensor and actuator.
2. Requiring More Than 35 in-lb (4 Nm) Actuator Torque.
3. This configuration is not supported by factory preloaded applications. Programming is required.

## Open-to-Wireless Series – Wireless Receiver Add-on



To reduce the cost of installation, and minimize the impact on existing partition walls, the Wireless Receiver enables these controllers to communicate with a line of wireless battery-less room sensors and switches. These Wireless Receivers are available in EnOcean 315MHz and 868.3MHz versions.



Note that controllers have one wireless port to support a single Wireless Receiver.

For more information about the EnOcean and Open-to-Wireless technologies, refer to the Open-to-Wireless Solution Guide. For more information about the Wireless Receiver module, refer to the [Wireless Receiver Datasheet](#). These documents can be found on our web site.

## Supported Platforms



### EC-Net<sup>AX</sup> Solution

The EC-Net<sup>AX</sup> multi-protocol integration solution is web-enabled and powered by the Niagara<sup>AX</sup> Framework, establishing a fully Internet-enabled, distributed architecture for real-time access, automation and control of devices. The EC-Net<sup>AX</sup> open framework solution creates a common development and management environment for integration of LONWORKS<sup>®</sup>, BACnet<sup>®</sup> and other protocols. Regardless of manufacturer and protocol, the EC-Net<sup>AX</sup> system provides a unified modeling of diverse systems and data, providing one common platform for development, management and enterprise applications.

### LONWORKS Network Services (LNS)



The LNS<sup>®</sup> client-server platform allows multiple users, running different LNS-compatible applications, to access a common source for the directory, installation, management, monitoring and control services for the network system being managed. Distech Controls' Lonwatcher is an example of a LNS-based network management tool that can use Plug-Ins to configure and monitor controllers and devices in the control system.

## EC-Net<sup>AX</sup> Wizards and LNS Plug-Ins

### EC-Net<sup>AX</sup> Px Graphics Page Support for Preloaded Applications with EC-Net<sup>AX</sup> dc *gfxApplications*



In the EC-Net<sup>AX</sup> solution, dc *gfxApplications* provide ready-to-use Px graphics pages for the ECL-VAV series of factory preloaded controllers. Once the controller is online, select any one of the standard VAV pre-configured controller applications to use. This provides a proven energy-efficient sequence of operation without any need for programming.

The graphics on the Px graphics page automatically update to show the currently selected controller application, the current VAV box's operational parameters with the ability to configure and override operation.

### EC-*gfxProgram* Graphical Programming Interface (GPI)

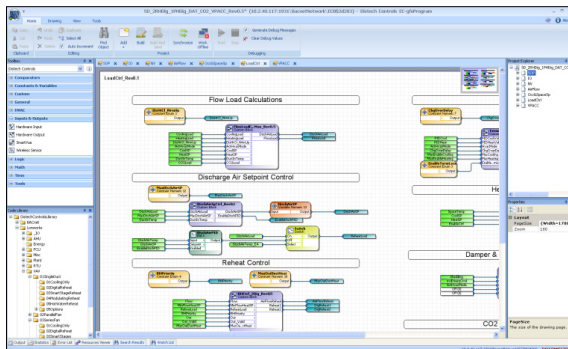

Distech Controls' EC-*gfxProgram* is a programming tool that allows you to quickly create control sequences by "dragging and dropping" block objects and then linking the objects with a simple "click, select and release". Select objects from an extensive library of over 100 commonly used functions as well as create your own custom blocks. With a user-friendly interface and intuitive programming environment, HVAC programming could not be easier. Refer to the EC-*gfxProgram* datasheet for more information.

- Program both ECP and ECL Series LONWORKS and ECB Series BACnet controllers with the same tool.
- Supplied as freeware – there are no associated licensing costs.
- Live debugging allows user to view code execution, input/output values and to detect errors in real-time.
- A code library for managing your favorite or most commonly used code or code sections or use *gfxApplications* which allows you to fine-tune the code to meet engineering-specific requirements, while providing full integration of ready-to-use Px graphics pages from dc *gfxApplications*.

### EC-Net<sup>AX</sup> Scheduling / EC-Schedule LNS Plugin / EC-*gfxProgram* EC-Schedule

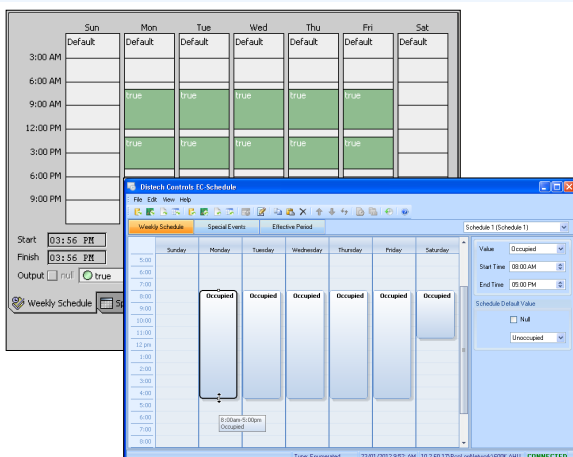

Configure the controller's built-in schedules and holidays from EC-Net<sup>AX</sup> solution (ECB and ECL series controllers), LNS (ECL series controllers), or directly from within EC-*gfxProgram* (ECB and ECL series controllers) with an easy-to-use point, drag, and click interface. It features a weekly schedule for regular, repeating, events by "time-of-day" and "day-of-week", while a holiday schedule is available to define events for specific days.

- Easily configure schedules using a graphical slider.
- Allows you to easily copy and paste entries. Duplicate a schedule entry for Monday to Friday.
- Special events allow you to set exceptions such as holidays to a schedule.
- Holidays can be set for recurring events such as the 9<sup>th</sup> day, or the 3<sup>rd</sup> Thursday of a given month.
- A schedule has an effective period during which it is active.
- Schedule provides Next State and Time to Next State that are ideal for use with programming functions such as Optimum Start or Morning Warm Up.

## Complementary Products

### Temperature Sensors

#### Allure EC-Smart-Vue Series



Line of communicating room temperature sensors with communication jack, a backlit-display and configurable graphic menus that allow occupants to set occupancy, setpoint adjustment, fan speed, or any other system parameters. Models are available with any combination of the following options: Humidity sensor, motion sensor, and CO<sub>2</sub> sensor. The ECO-Vue™ icon (  ) shows how environmentally-friendly the zone's energy consumption is in real time.

#### Allure EC-Sensor Series



Line of discrete temperature sensors. Models are available with the following options: Communication jack, occupancy override button, setpoint adjustment, and fan speed selection.

### Open-to-Wireless Sensors and Switches

#### Allure Wireless Battery-less ECW-Sensor Series



Line of wireless, battery-less room temperature sensors. Models are available with the following options: Occupancy override button, setpoint adjustment, and fan speed selection. These sensors are available in EnOcean 315MHz and 868.3MHz versions. The controller must be equipped with a [Wireless Receiver](#).

#### Wireless Sensors and Switches



A wide range of self-powered wireless sensors and switches, including the following: Motion detector and light sensor, 2-/4-channel wireless light switches (North American and European models), outdoor temperature sensor, surface temperature contact sensor, duct temperature sensor, and more.

These sensors are available in EnOcean 315MHz and 868.3MHz versions. The controller must be equipped with a [Wireless Receiver](#).

For more information about the available wireless sensors and switches, refer to the [Open-to-Wireless Solution Guide](#) which can be found on our web site.

### Other



VAV Terminal Block Cover

A cover designed to conceal the wire terminals. Required to meet local safety regulations in certain jurisdictions.

For more information on these or other Distech Controls products, refer to our web site.

## Controller Dimensions

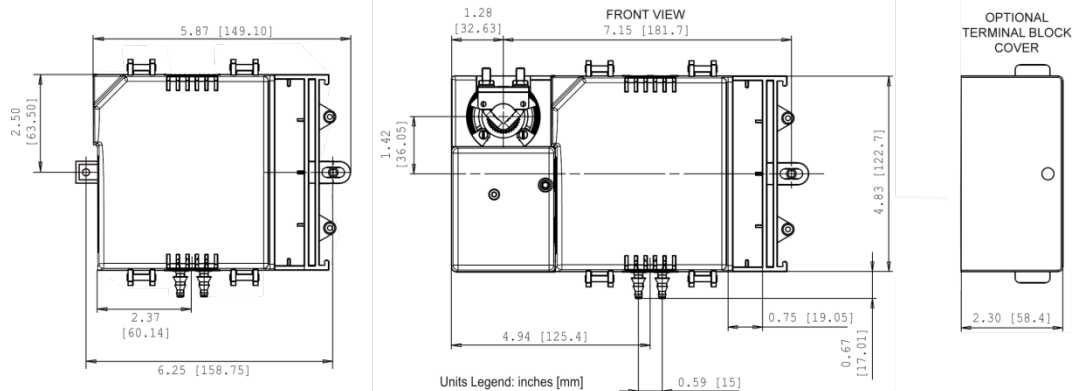

## Product Specifications

### Power

Voltage	24VAC; $\pm 15\%$ ; 50/60Hz; Class 2
Protection	2.0A user-replaceable fuse 3.0A user-replaceable fuse for triacs when using the internal power supply
Power Consumption	10 VA typical plus all external loads <sup>1</sup> 85 VA maximum

### Interoperability

Communication	LonTalk protocol
Transceiver	FT 5000 Free Topology Smart Transceiver
Channel	TP/FT-10; 78Kbps
LONMARK Interoperability Guidelines	Version 3.4
Device Class	SCC VAV
LONMARK Functional Profile	
- Input objects	Open-Loop Sensor #1
- Output objects	Open-Loop Actuator #3
- Node object	Node object #0
- Real Time Clock	Real Time Keeper #3300
- Scheduler	Scheduler #20020
- Calendar	Calendar #20030
- Programmable Device	Static Programmable Device #410
- SCC Object	SCC VAV #8502

### Hardware

Processor	STM32 (ARM Cortex™ M3) MCU, 32 bit
CPU Speed	68 MHz
Memory	384 kB Non-volatile Flash (applications) 1 MB Non-volatile Flash (storage) 64 kB RAM
Real Time Clock (RTC)	Built-in Real Time Clock without battery: Network time synchronization is required at each power-up cycle before the RTC becomes available
Status Indicator	Green LEDs: Power Status & LAN Tx Orange LEDs: Controller Status & LAN Rx

### Environmental

Operating Temperature	0°C to 50°C; 32°F to 122°F
Storage Temperature	-20°C to 50°C; -4°F to 122°F
Relative Humidity	0 to 90% Non-condensing

### Inputs

Input Types	Universal; software configurable
-Voltage	- 0 to 10VDC (40k $\Omega$ input impedance) - 0 to 5VDC (high input impedance)
-Current	0 to 20mA with 249 $\Omega$ external resistor (wired in parallel)
-Digital	Dry contact
-Pulse	Dry contact; 500ms minimum ON/OFF
-Resistor	0 to 350 K $\Omega$ . All thermistor types that operate in this range are supported. The following temperature sensors are pre-configured:
Thermistor	10K $\Omega$ Type 2, 3 (10K $\Omega$ @ 25°C; 77°F)
Platinum	Pt1000 (1K $\Omega$ @ 0°C; 32°F)
Nickel	RTD Ni1000 (1K $\Omega$ @ 0°C; 32°F) RTD Ni1000 (1K $\Omega$ @ 21°C; 69.8°F)
Input Resolution	16-bit analog / digital converter
Differential Pressure	0 to 2.0 in. W.C. (0 to 500 Pa)
-Input Resolution	0.00007 in. W.C. (0.0167 Pa)
-Air Flow Accuracy	$\pm 4.0\%$ @ > 0.05 in. W.C. (12.5 Pa) $\pm 1.5\%$ once calibrated through air flow balancing @ > 0.05 in. W.C. (12.5 Pa)
Power Supply Output	15VDC; maximum 80mA (4 inputs $\times$ 20mA each)

### Outputs

Digital	24 VAC Triac, digital (on/off), PWM, or floating; software configurable
	- 0.5A continuous
	- 1A @ 15% duty cycle for a 10-minute period
	- PWM control: adjustable period from 2 to 65sec.
	- Floating control:
	- Min pulse on/off: 500msec.
	- Adjustable drive time period
	External or internal power supply (jumper selectable)
Universal	Linear (0 to 10VDC)
	Digital (on/off), PWM, or floating (0 - 12VDC); software configurable. Built-in snubbing diode to protect against back EMF, for example when used with a 12VDC relay.
	- PWM control: Adjustable period from 2 to 65sec.
	- Floating control:
	- Min pulse on/off: 500msec.
	- Adjustable drive time period
	- 20mA maximum @ 12VDC
	- Minimum load resistance 600 $\Omega$
Output Resolution	10-bit digital / analog converter

1. External loads must include the power consumption of any connected modules such as an Allure EC-Smart-Vue. Refer to the respective module's datasheet for related power consumption information.

## Product Specifications (continued)

### Enclosure

Material	FR/ABS
Color	Black & blue casing & grey connectors
Dimensions (with Screws)	
- ECL-VAV-N	4.8 L × 5.9 W × 2.5" H (122.7 × 149.1 × 63.0mm)
- Other models	4.8 L × 8.4 W × 2.5" H (122.7 × 214.3 × 63.0mm)
Shipping Weight	ECL-VAV-N: 0.92lbs (0.42kg) Other models: 2.30lbs (1.05kg)

### Integrated Damper Actuator

Motor	Belimo LMZS-H brushless DC motor
Torque	35 in-lb, 4 Nm
Degrees of Rotation	95° adjustable
Fits Shaft Diameter	5/16 to 3/4"; 8.5 to 18.2mm
Acoustic Noise Level	< 35 dB (A) @ 95° rotation in 95 seconds

### Wireless Receiver<sup>1</sup>

Communication	EnOcean wireless standard
Number of wireless inputs <sup>2</sup>	18
Supported Wireless	Wireless Receiver (315)
Receivers	Wireless Receiver (868)
Cable	Telephone cord
- Connector	4P4C modular jack
- Length (maximum)	6.5ft; 2m

### Standards and Regulation



CE -Emission	EN61000-6-3: 2007; Generic standards for residential, commercial and light-industrial environments
-Immunity	EN61000-6-1: 2007; Generic standards for residential, commercial and light-industrial environments
FCC	This device complies with FCC rules part 15, subpart B, class B



UL Listed (CDN & US)	UL916 Energy management equipment
Material <sup>3</sup>	Plastic housing, UL94-5VB flammability rating Plenum rating per UL1995



CEC Appliance Database Appliance Efficiency Program<sup>4</sup>

1. Available when an optional external Wireless Receiver module is connected to the controller. Refer to the Open-to-Wireless Solution Guide for a list of supported EnOcean wireless modules.
2. Some wireless modules may use more than one wireless input from the controller.
3. All materials and manufacturing processes comply with the RoHS directive  and are marked according to the Waste Electrical and Electronic Equipment (WEEE) directive .
4. California Energy Commission's Appliance Efficiency Program: The manufacturer has certified this product to the California Energy Commission in accordance with California law.

### Allure EC-Smart-Vue

Communication	RS-485
Number of sensors per controller	Up to 4, in daisy-chain configuration
Cable	Cat 5e, 8 conductor twisted pair
Connector	RJ-45

### Communication Protocols



# Functional Profile – ECL-VAVS-O, ECL-VAVS, ECL-VAV, ECL-VAV-N, and ECL-VVTS

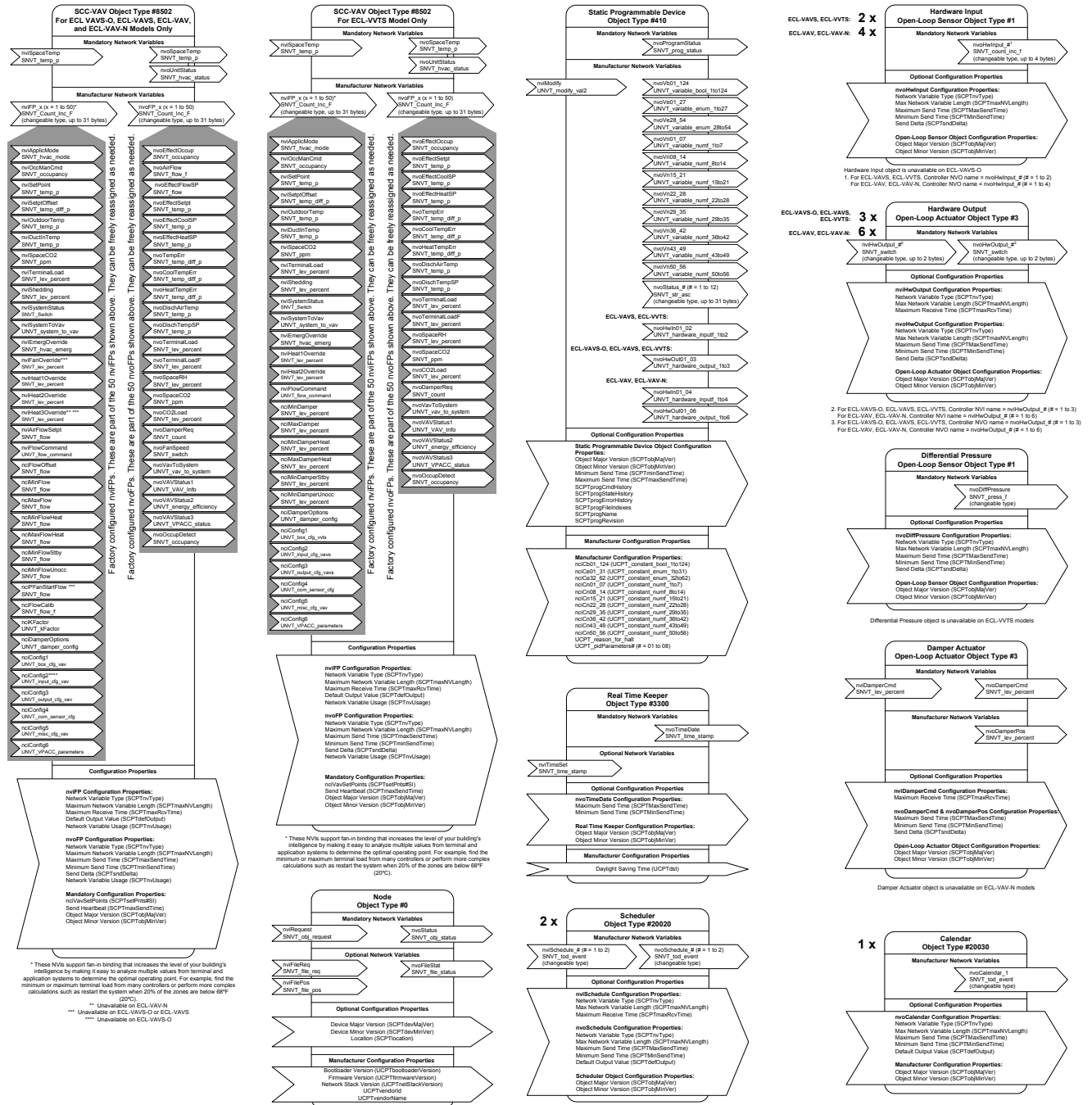

## Total Quality Commitment

All Distech Controls product lines are built to meet rigorous quality standards. Distech Controls is an ISO 9001 registered company.

©, Distech Controls Inc., 2012. All rights reserved. Specifications subject to change without notice.

Images are simulated. Distech Controls, the Distech Controls logo, Open-to-Wireless, Innovative Solutions for Greener Buildings, ECO-Vue, and Allure are trademarks of Distech Controls Inc.; LONWORKS, LON, LONMARK, LNS, LonTalk are registered trademarks of Echelon Corporation; Niagara<sup>AX</sup> Framework is a registered trademark of Tridium, Inc.; ARM Cortex is a registered trademark of ARM Limited; BACnet is a registered trademark of ASHRAE; Windows, Visual Basic.Net are registered trademarks of Microsoft Corporation. EnOcean is a registered trademark of EnOcean GmbH. All other trademarks are property of their respective owners.

