

# ASL-410-THC

## Outdoor Lighting Controller 0..10V

- Lonmark certified Outdoor Luminair controller
- Power, voltage and current measurement
- Generic purpose Output relay.
- Suitable for Outdoor Lighting applications.
- Regulated output 0..10V for dimming control
- Lonmark functional profiles:
  - 0 Nodeobject
  - 3512 SmartLuminairController
- Neuron® PL3120 @ 5Mhz.
- Firmware: PG20A00L01001
- Program ID: 80:00:E1:22:00:04:10:01
- CE – Europe
- EN 60950-1, EN 55022, EN 55024



### TECHNICAL DATA

#### FEATURES

ELECTRICAL	
Power Supply	85 – 265VAC
Frequency (AC Supply source)	50-60 Hz
Overvoltage	NORM IEC 61000-4-5 (4KV)
Overload	Fast fuse 10 <sup>3</sup> 5X20mm (IEC-127-2 Standard sheet 2)
Power consumption	<10 W
OUTPUTS	
Analog Output	1 x 0..10V (Resolution 0.04V)
Output relay (Phase cut contacts)	1x 10A cosφ = 1
COMMUNICATIONS	
Type	LonWorks (ISO/IEC 14908-2)
Transceiver	PL-3120
Channel	PL-20C
MEASUREMENTS	
Current measurement range	0..2,6A
Current measurement accuracy	5% end of scale
Current measurement resolution	0.1 mA
Voltage measurement range	85 – 265 AC
Voltage measurement accuracy	3% end of scale
Voltage measurement resolution	0.1 V
PACKAGE	
Mechanical restraint	ABS plastic box
Dimensions (milimeters)	94.7 x 45.5 x 79
Colour	Black
IP	IP20 or IP66 with PC121207 enclosure
ENVIRONMENT	
Operating temperature	-10°C..75°C
Storage temperature	-10°C..75°C
Operating humidity	5%..90%

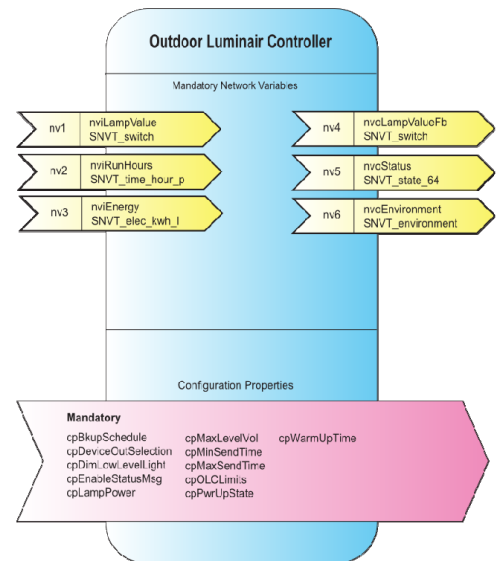



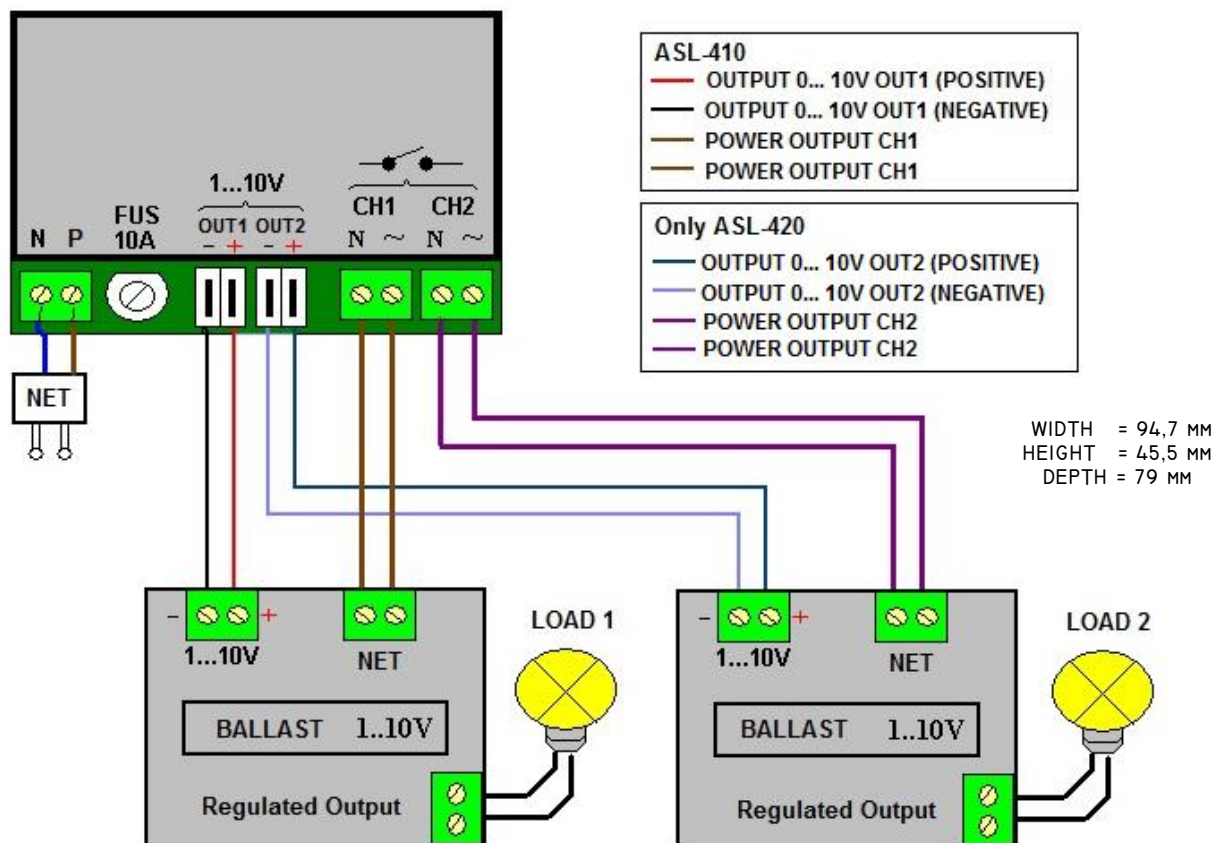
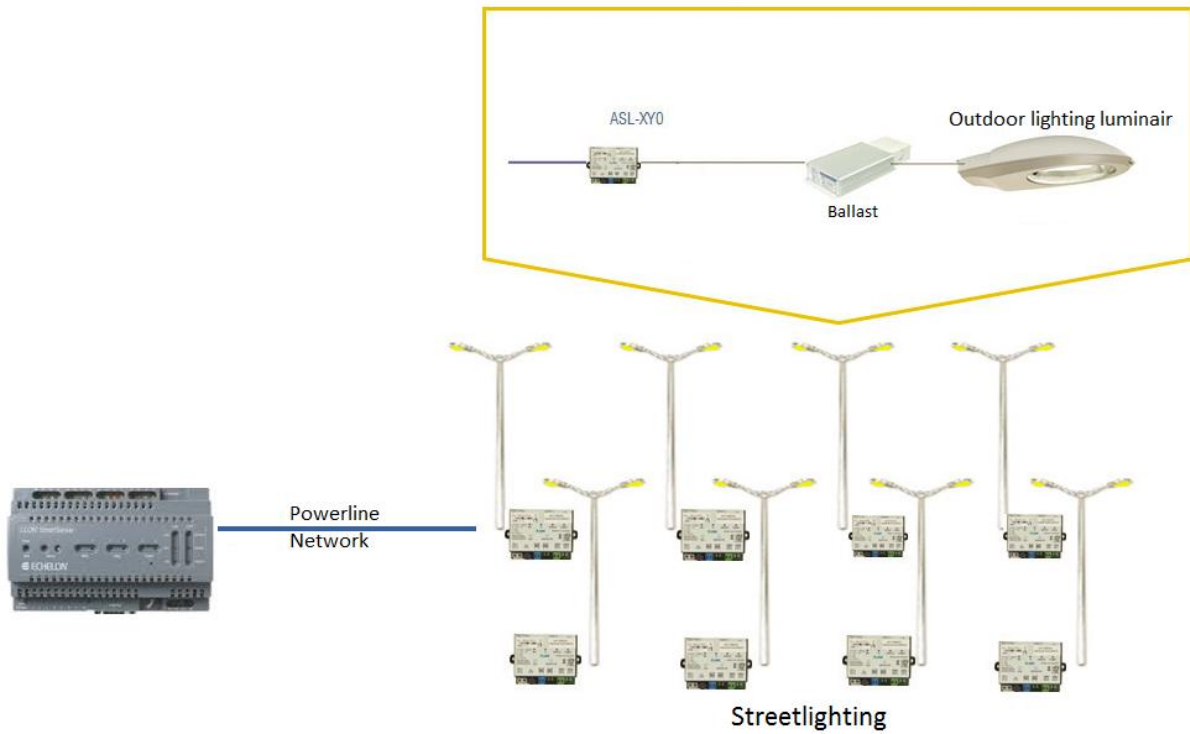

### FUNCTIONAL FEATURES

- Smart Outdoor luminair controller for dimming 0..10V.
- Magnetic contact service pin for easy installation.
- Self-ignition in the case of communication lost with Smart Server of Header control.
- Power consumption measurement capability.
- Versions with 0..10V and DALI interface.

DIAGRAMS



**RELATED PRODUCTS**

	<p><b>ISL-41X</b></p>	<p><b>Outdoor Luminair Controller</b>                  IP-66 LonWorks powerline device for outdoor luminair with 0..10V or PWM interface.</p>
	<p><b>ATE-420</b></p>	<p><b>Tri-phase Powerline Lonworks coupler</b></p>
	<p><b>ASL-520</b></p>	<p><b>Lonworks – DALI Outdoor Luminair Controller</b>                  LonWorks – DALI for outdoor lighting control with power consumption measurement capability.</p>
	<p><b>ICAAL</b></p>	<p><b>Autonomous lighting controller</b></p>
	<p><b>IWLON-460-PL</b></p>	<p><b>Echelon SmartServer</b>                  Lonworks power-line web server with management functions</p>

**Ordering information** 

**ASL-410-TCH**  
**Código: 231-71** 